

PLB386C# / R# - BOX (取り付け用金具未使用時)

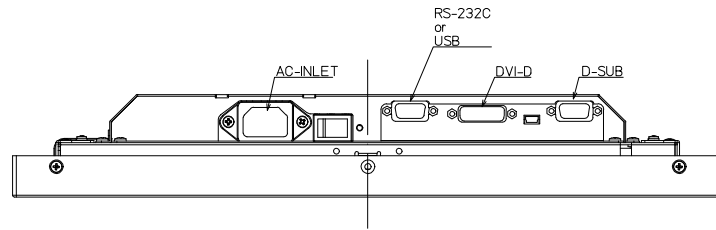

PLB386C# /R# -BOX (取り付け用金具使用時)

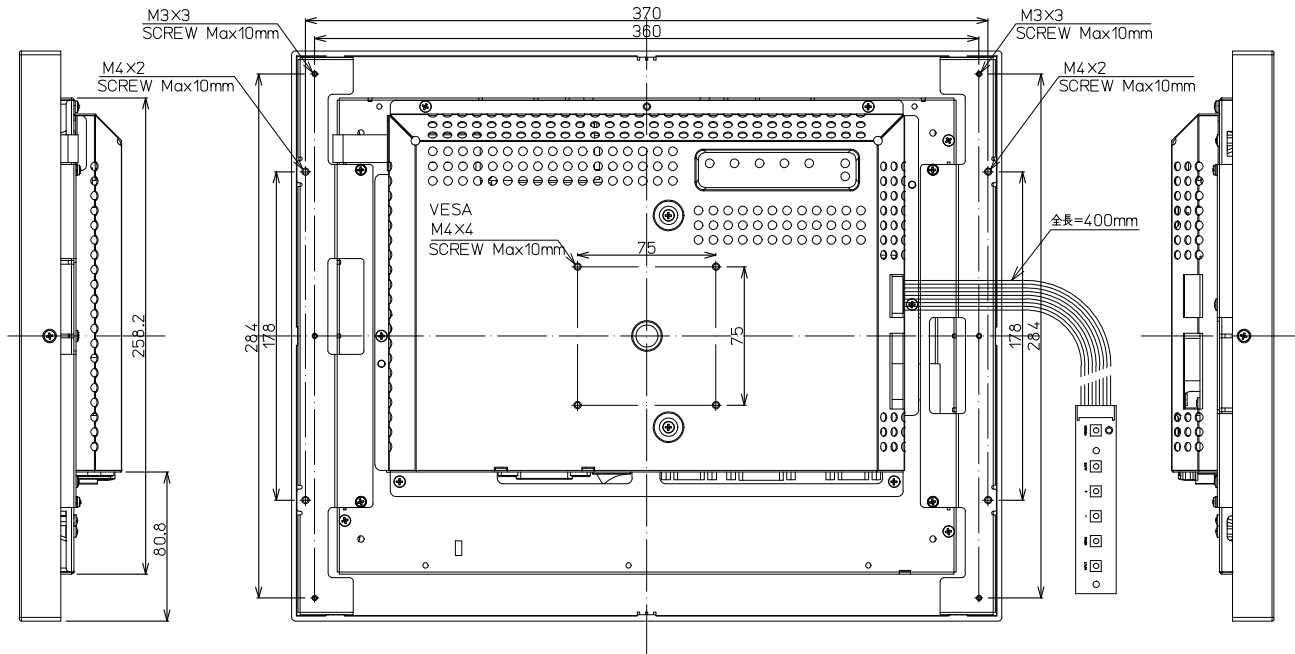
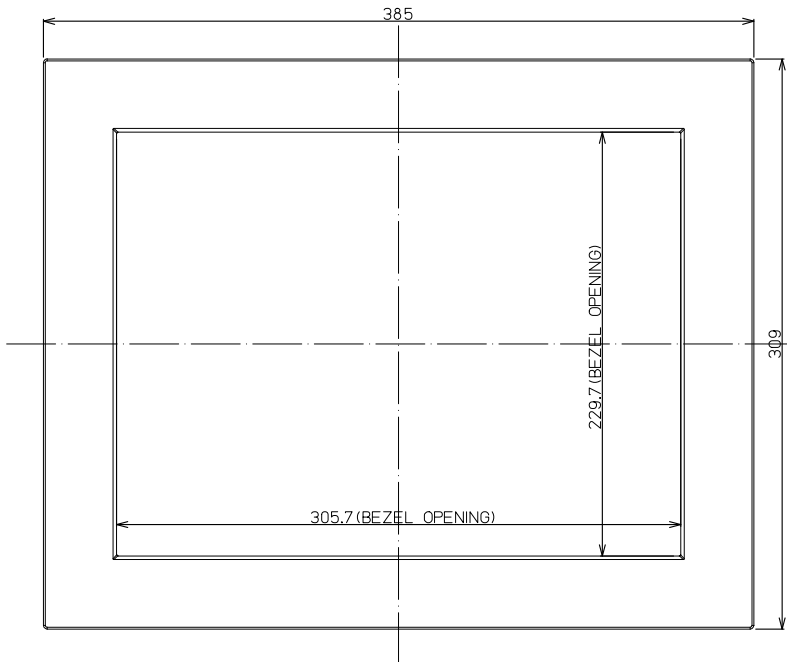
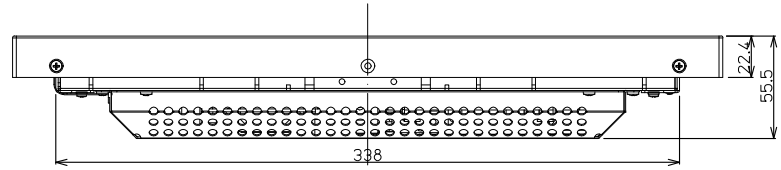
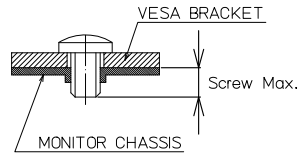
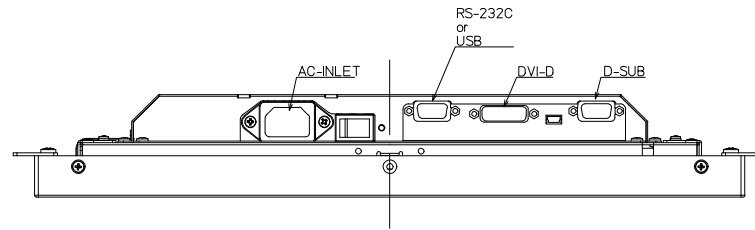
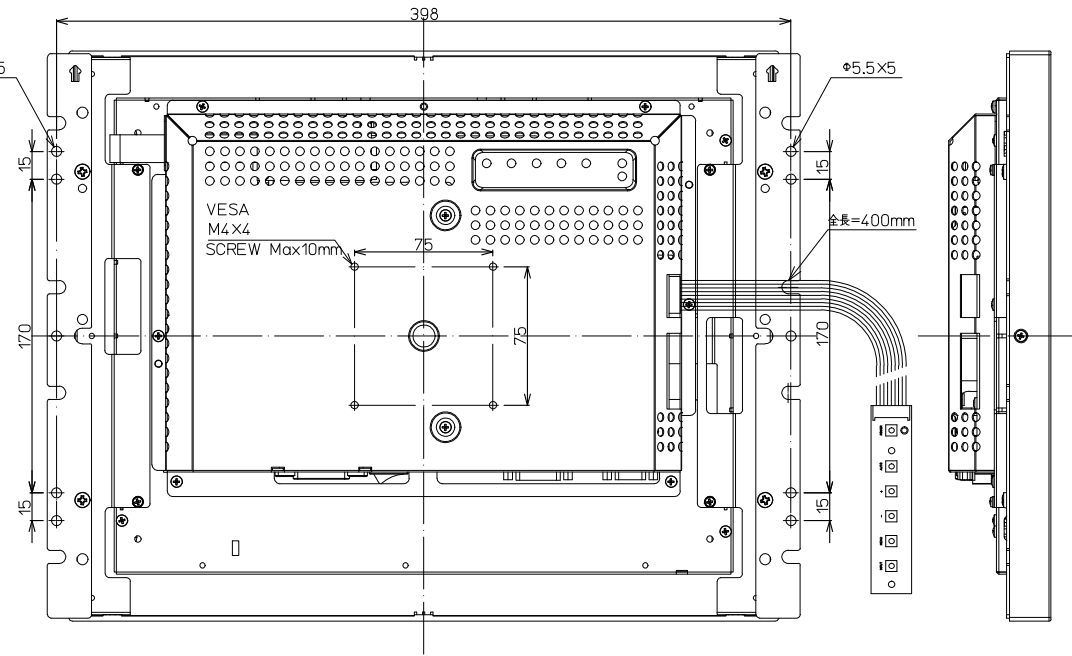
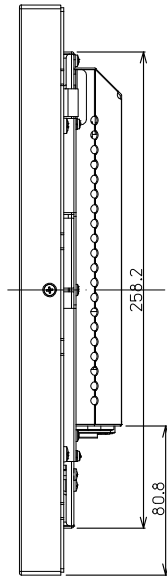
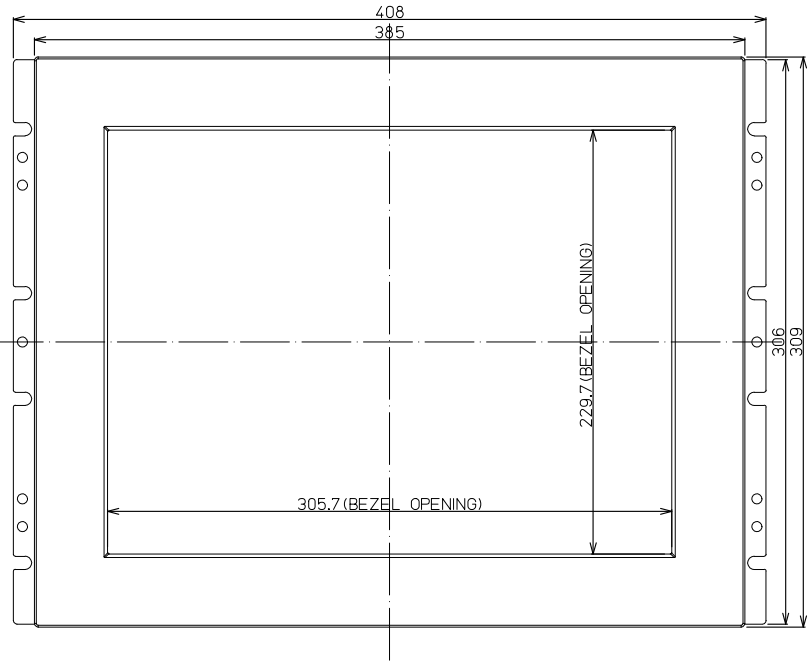
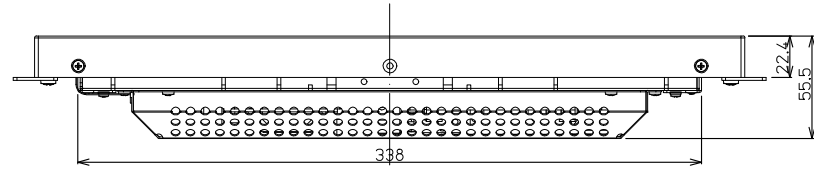
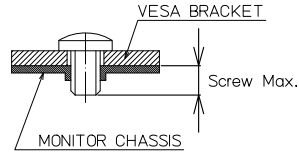

PLB386##-B#X (ベゼル取り外し状態)

※PLB386##-B#Xのベゼルと
固定板金を取り外すことにより、
下図のモジュール状態にてご使用いただけます。

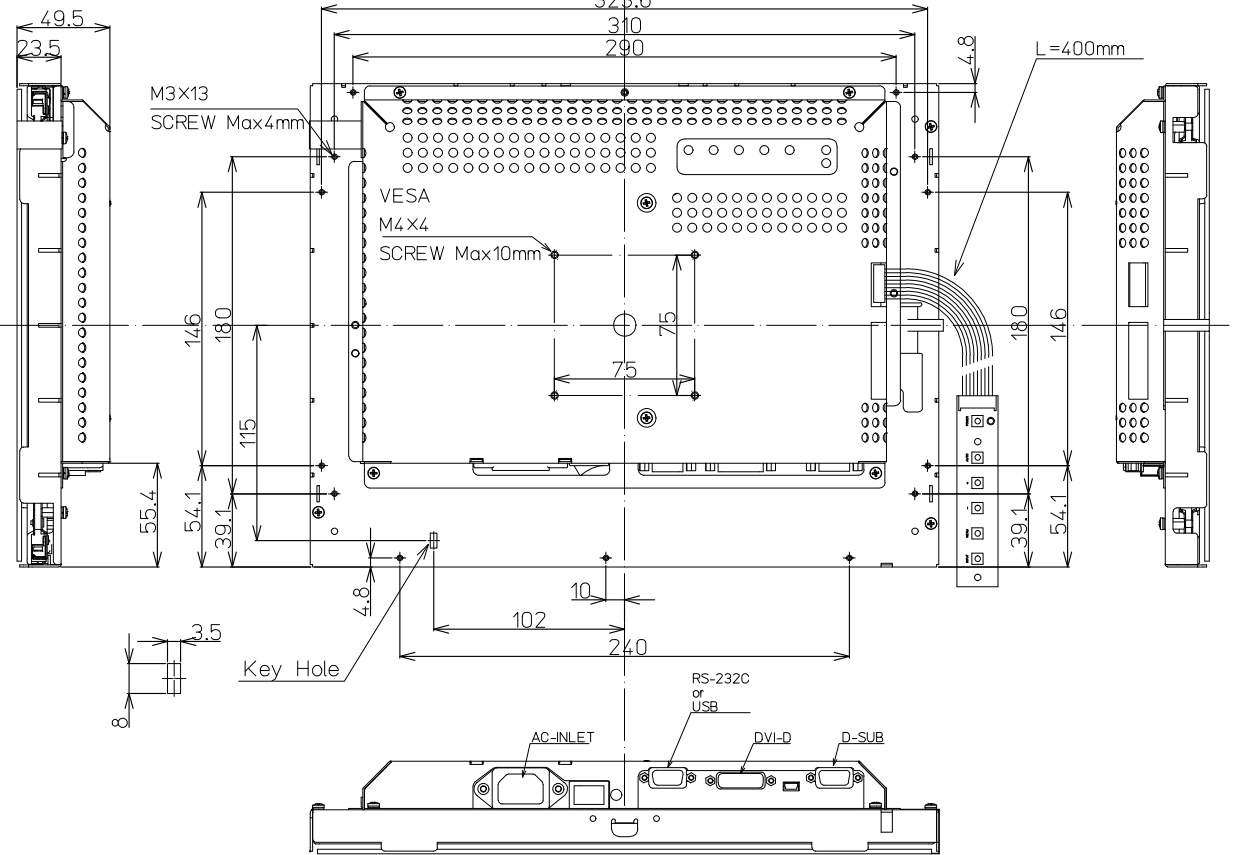
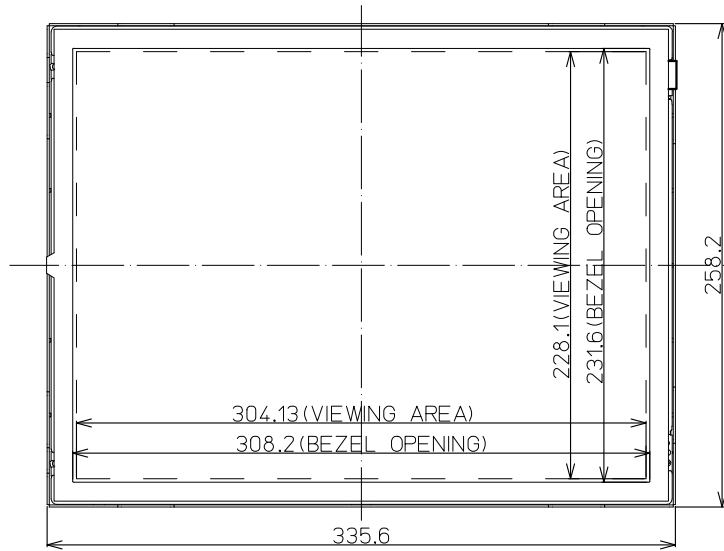
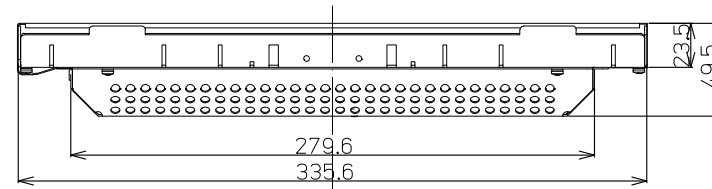
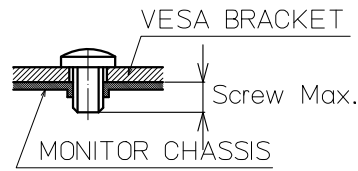

OSDコントロール基板外形図

